

Spin Dryers

Vegetable Dryer, 10kg with stainless steel basket

ITEM # _____

MODEL # _____

NAME # _____

SIS # _____

AIA # _____

601980 (ELX65XF5)

10 kg vegetable dryer with 65 lt basket volume. Spin drying automatic cycle. Stainless steel basket

Short Form Specification

Item No. _____

Body and panels in stainless steel, lid in plastic material. Removable stainless steel basket (65 litres). Flat and waterproof touch button control panel. Two cycles: "automatic" which alternates rotation with several sudden stops (for all vegetables); "manual" thanks to the adjustable timer up to 59 minutes (for delicate vegetables). Residual water is eliminated through an outlet pipe. Equipped with self-braking motor which stops the machine after the set drying time or if the lid is open during the cycle. IP55 and IP34 protection. V-ribbed belt drive. Basket rotation speed: 330 rpm. Load capacity: 10 kg, - 18 lettuce heads.

Main Features

- Spin drying automatic cycle with short drying time (1 to 2 minutes).
- "Automatic" cycle alternates rotation to several sudden stops, suitable for all vegetables.
- "Manual" cycle uses adjustable timer up to 59 minutes, to be used for delicate vegetables.
- Outlet pipe eliminates residual water.
- Timer with digital display and countdown.
- Safety device stops the machine when the cover is opened.
- Electrical braking system to stop basket rotation in a matter of seconds at the end of the cycle or when lid is opened.
- Heavy vegetables load per cycle: 10 Kg
- Light vegetables load per cycle: 18 units of lettuce heads.

Construction

- Stainless steel body and panels.
- Basket rotates at approximately 330 rpm.
- Removable stainless steel basket (base in aluminium), 65 liters capacity.

Included Accessories

- 1 of Additional stainless steel basket for 12 kg vegetable dryer PNC 653303

Optional Accessories

- Additional stainless steel basket for 12 kg vegetable dryer PNC 653303
- Additional plastic basket for 12 kg vegetable dryer PNC 653304

APPROVAL: _____

Front

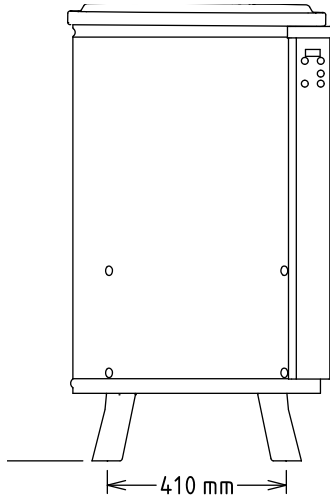

Side

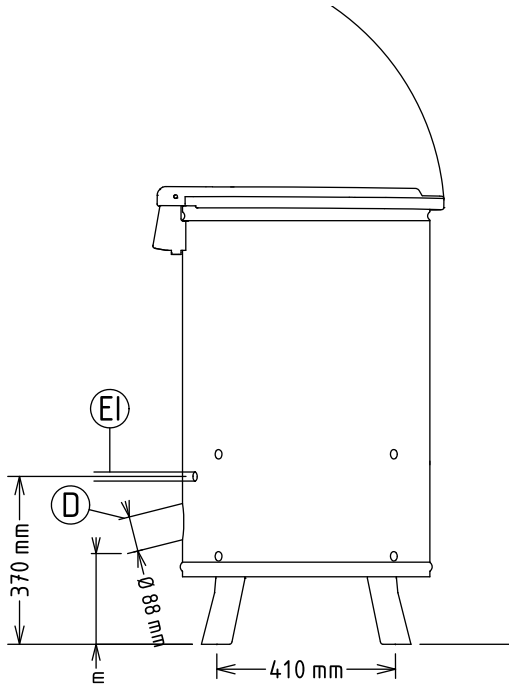

D = Drain
 EI = Electrical inlet (power)

Top

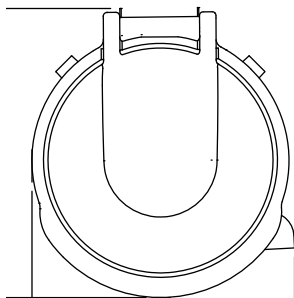
Electric

Supply voltage:	220-240/380-415 V/3 ph/50 Hz
Electrical power max.:	0.75 kW
Total Watts:	0.75 kW

Key Information:

External dimensions, Width:	578 mm
External dimensions, Depth:	639 mm
External dimensions, Height:	1005 mm
Shipping weight:	73 kg
Well Capacity:	65 lt
Usable well capacity:	65 lt
Load per cycle - light vegetables:	18 UNITS OF LETTUCE
Load per cycle - heavy vegetables:	